



Quick guide
for commissioning

Bluetooth Gateway



Our technology. Your success.
Pumps • Valves • Service



1

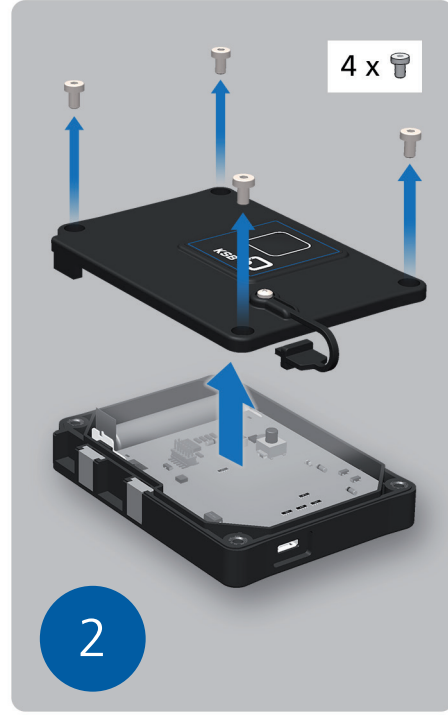

2

4 x

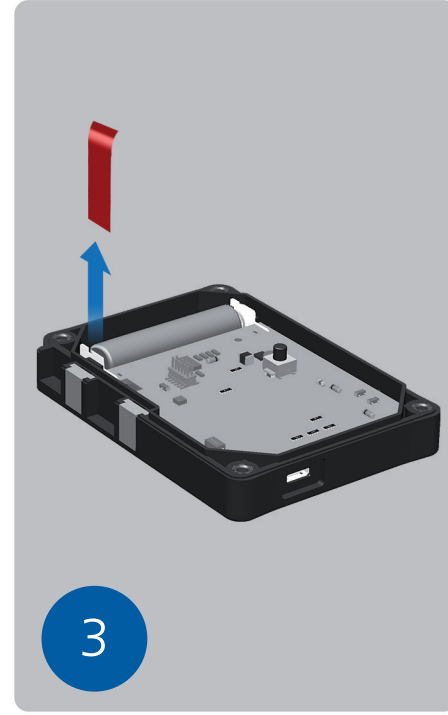

3



4

3 h



KSB SE & Co. KGaA
Johann-Klein-Straße 9
67227 Frankenthal
Tel. +49 6233 86-0
E-Mail: info@ksb.com



5

4 x

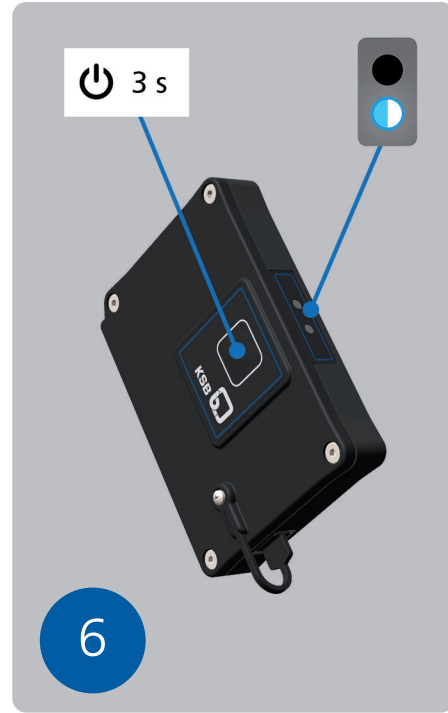

6

3 s

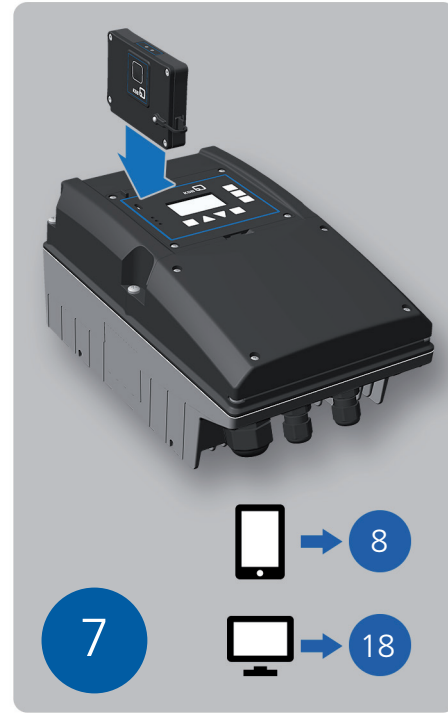

7

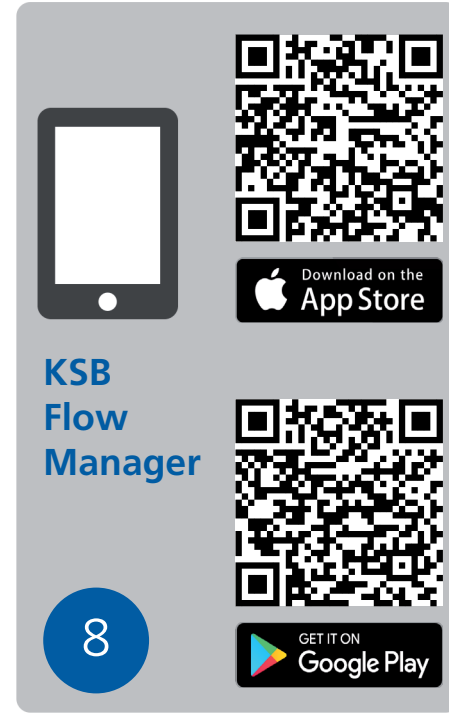
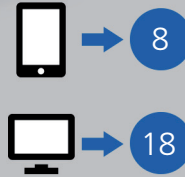

8

**KSB
Flow
Manager**

Download on the
App Store

GET IT ON
Google Play



9

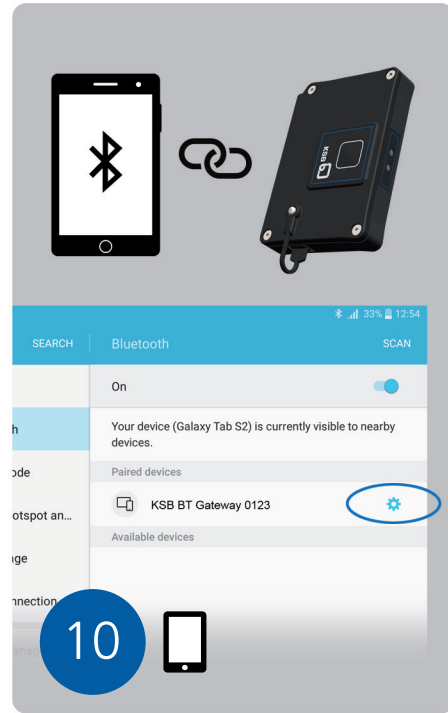

10



11

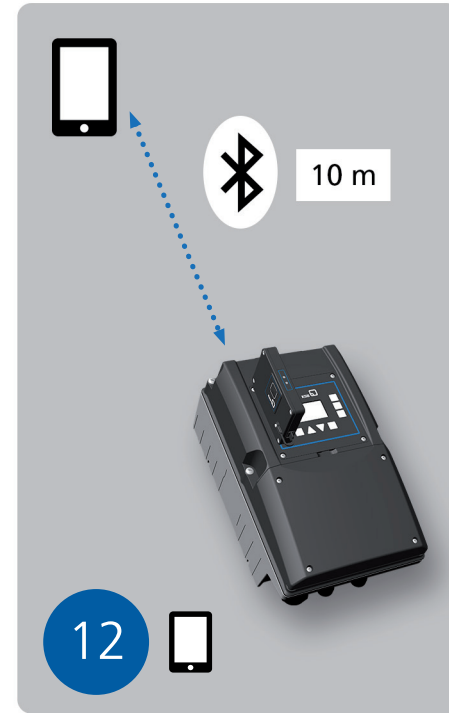

12

10 m

This quick guide accompanies the installation/
operating manual. All information contained in
the installation/operating manual of supported
products must be observed.

Legal Information/Copyright

Quick guide for commissioning

All rights reserved. The contents provided
herein must neither be distributed, copied,
reproduced, edited or processed for any other
purpose, nor otherwise transmitted, published
or made available to a third party without the
manufacturer's express written consent.
Subject to technical modification without prior
notice.

© KSB SE & Co. KGaA, Frankenthal
01.09.2018



KSB Flow Manager

13

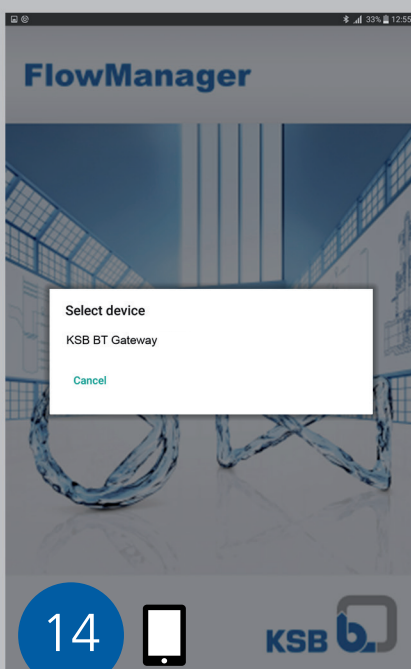

14

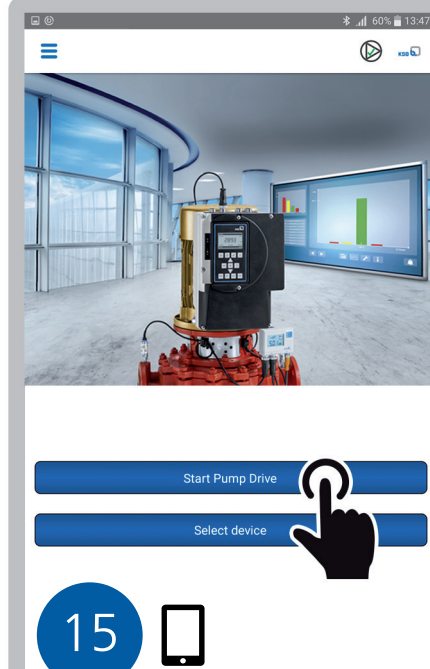

15

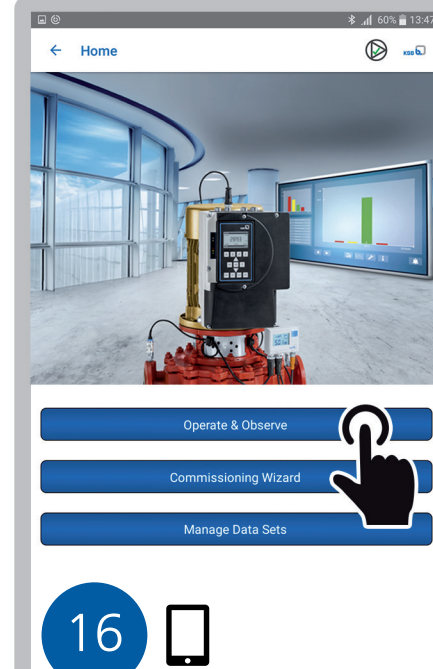

16

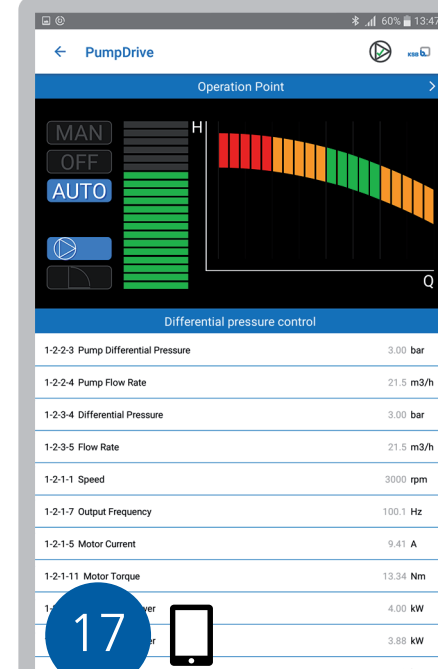

17



KSB Servicetool PACTware



https://www.ksb.com/ksb-en/Products_and_Services/automation-technology/software/

18

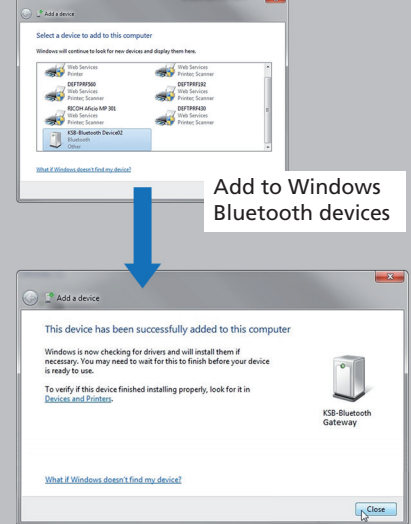

19

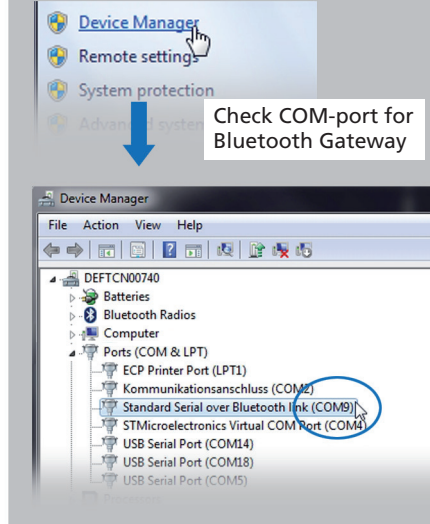

20



21

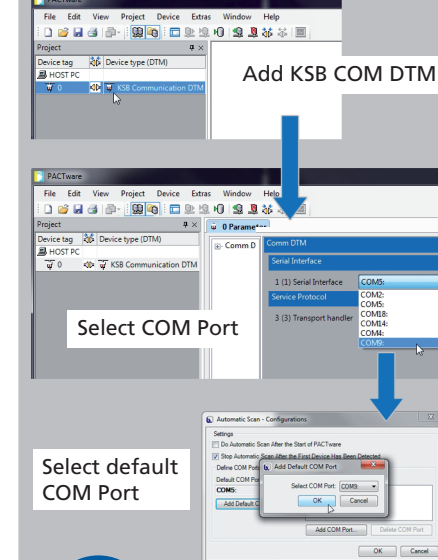

22

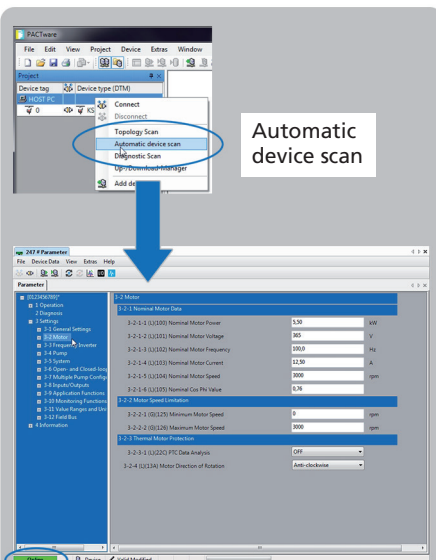

23

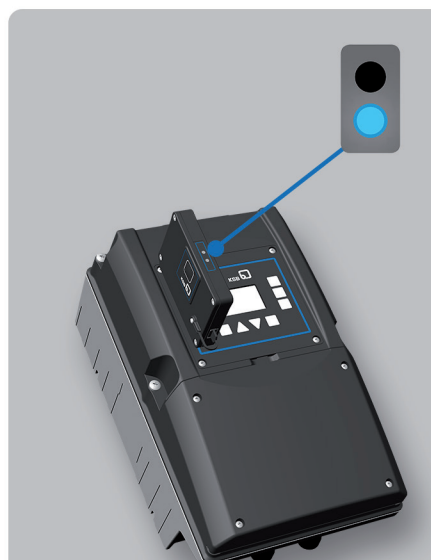

24

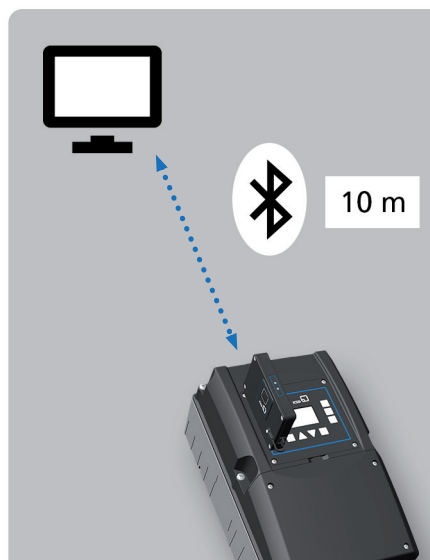

25



LED codes BT-gateway

- Blue flashing**
Searching for BT-communication
- Blue permanently**
BT-communication paired
- LED off**
Standby/Off
- Red permanently**
BT-gateway empty battery
- Yellow flashing**
Slow charging (at beginning of the charging process)
- Green flashing**
Fast charging
- Green permanently**
Fully loaded battery

Our technology. Your success.

Pumps • Valves • Service

